

Art. Nr. 2834196

1/6

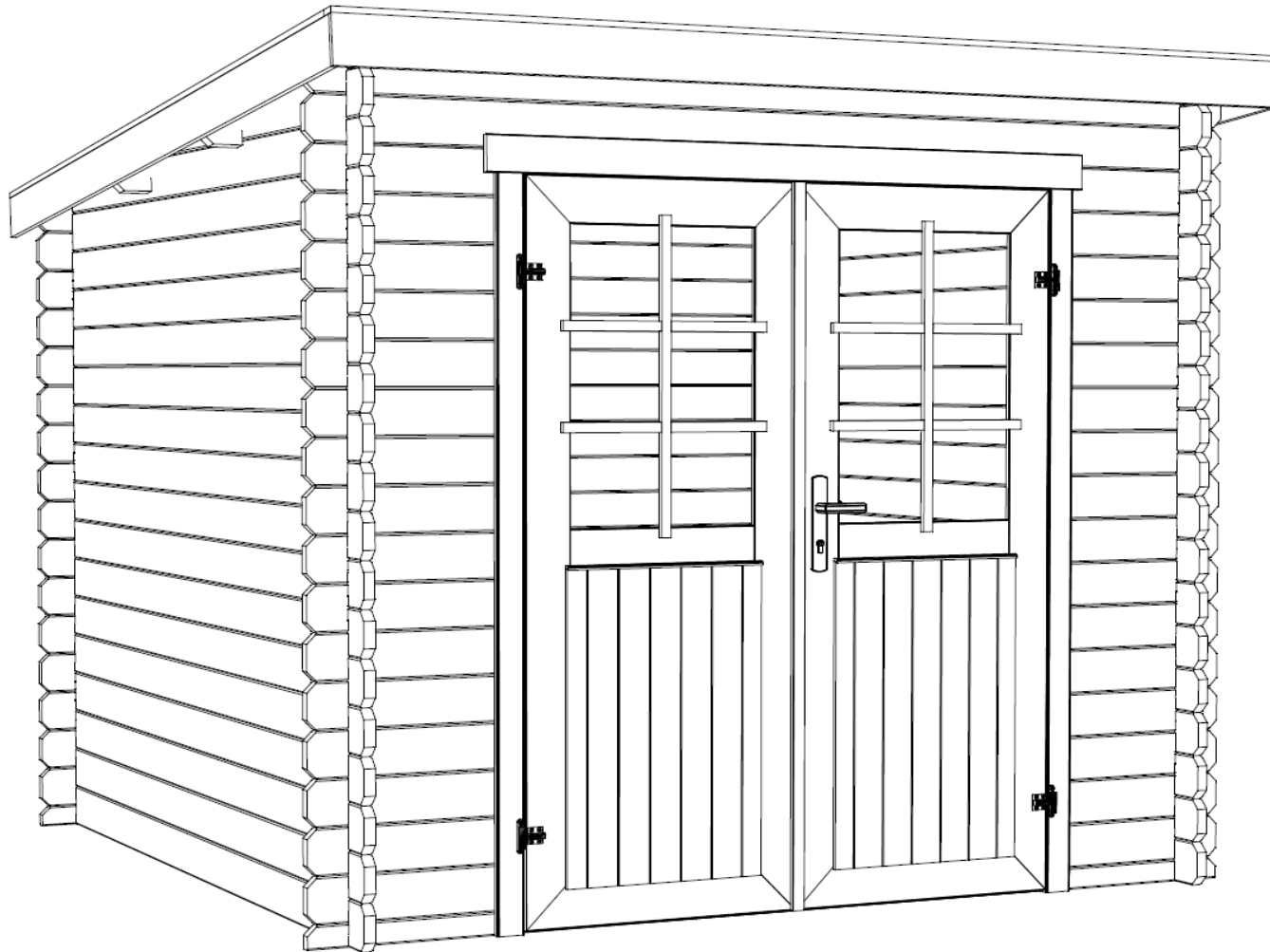

22/10/2023

Art.Nr. 2834196



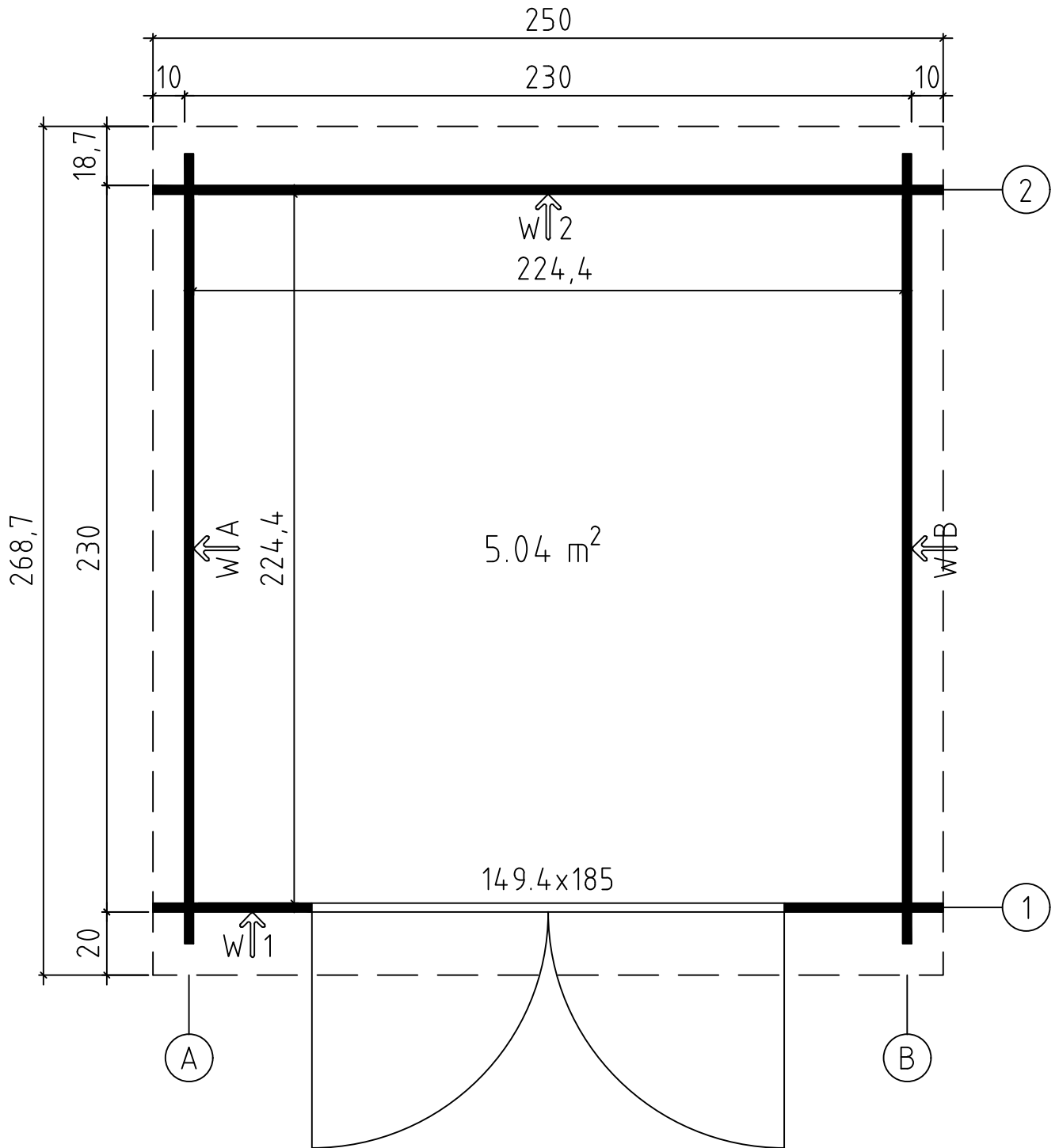

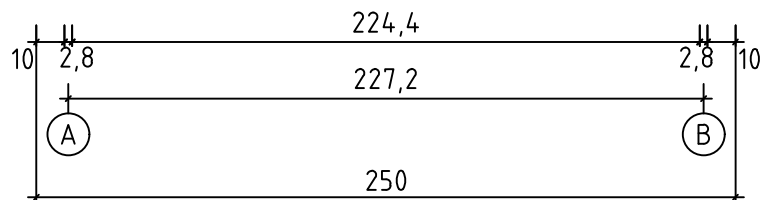
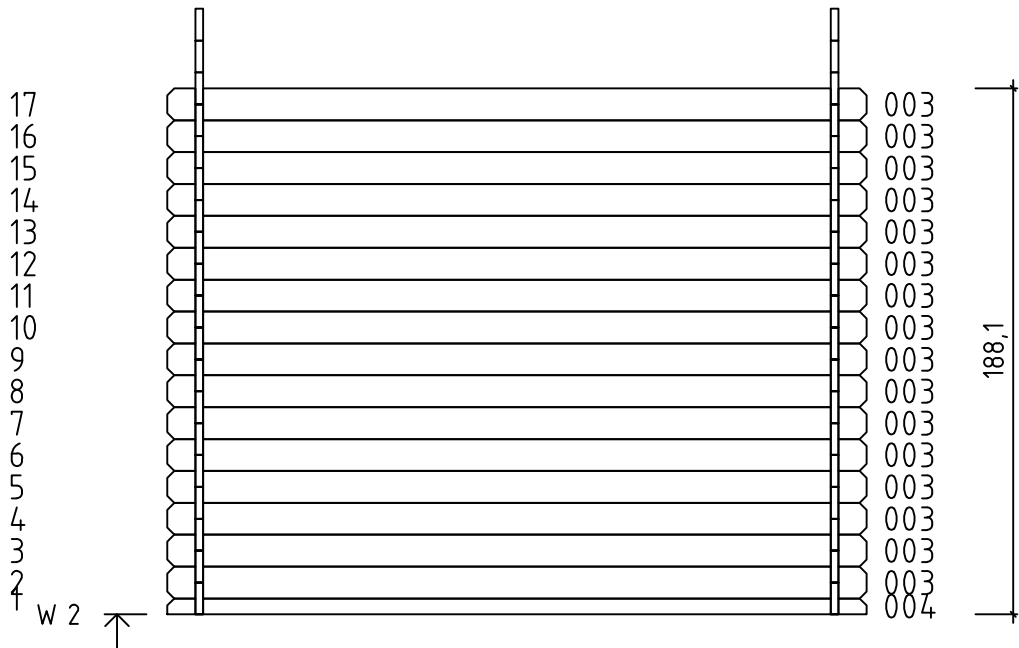
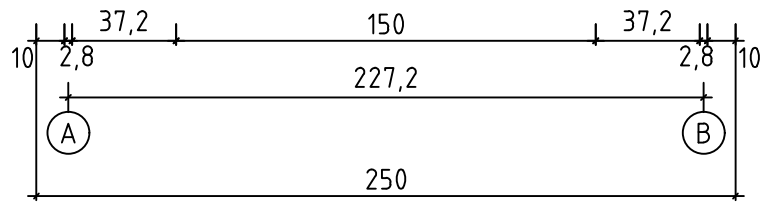
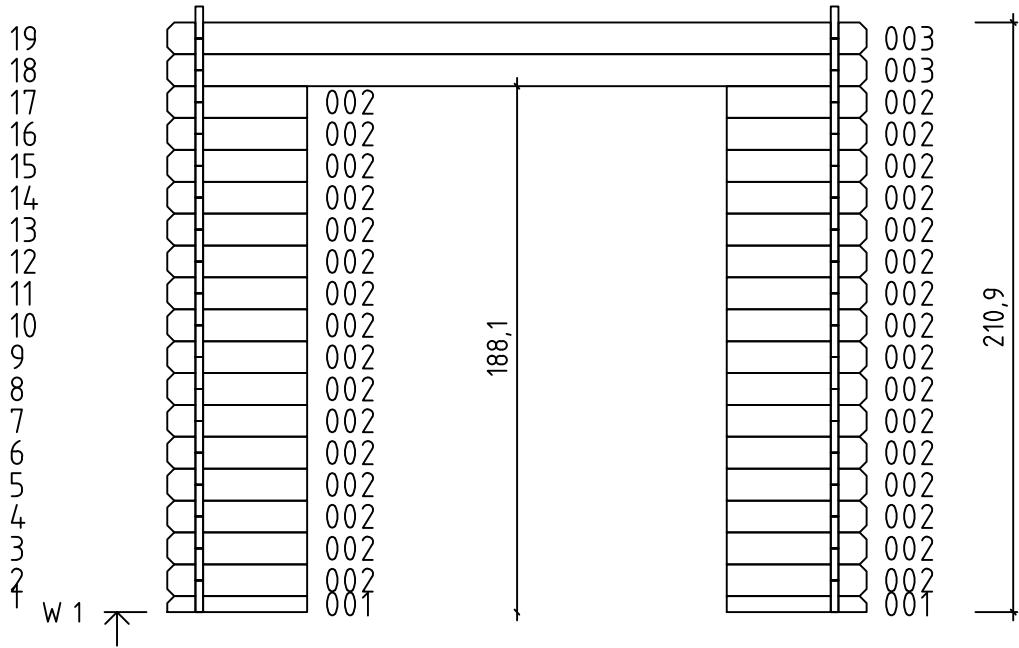



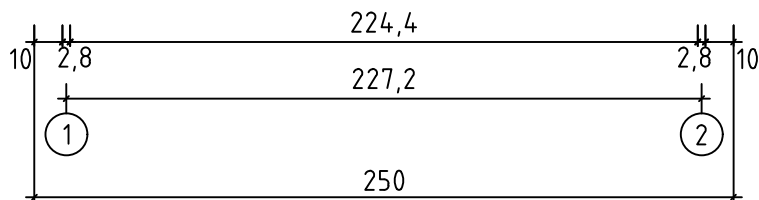
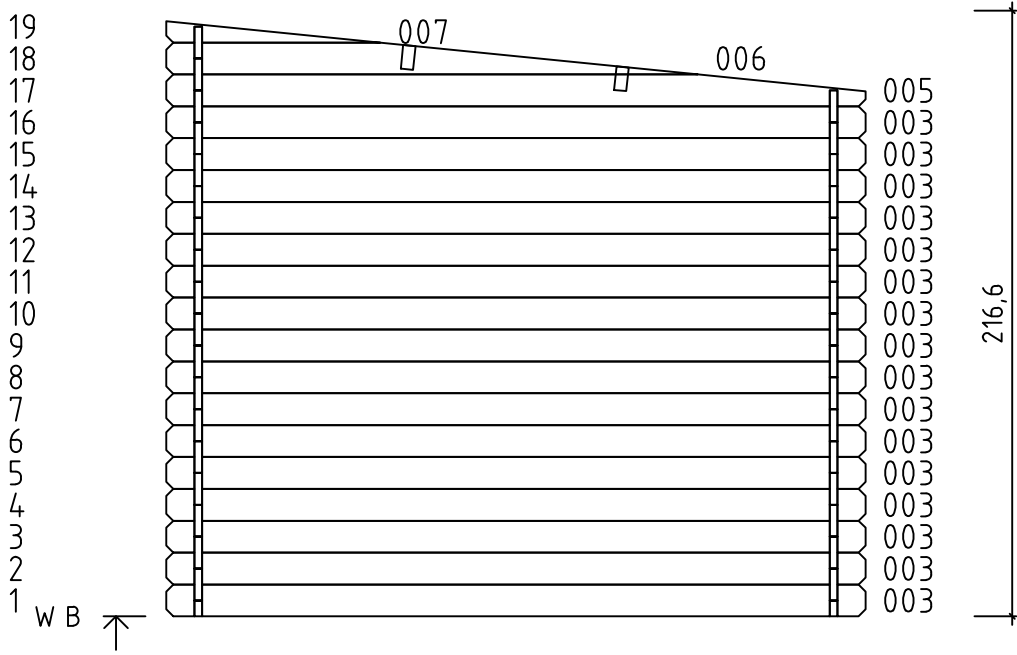
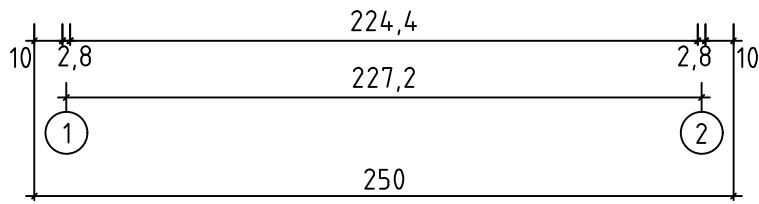
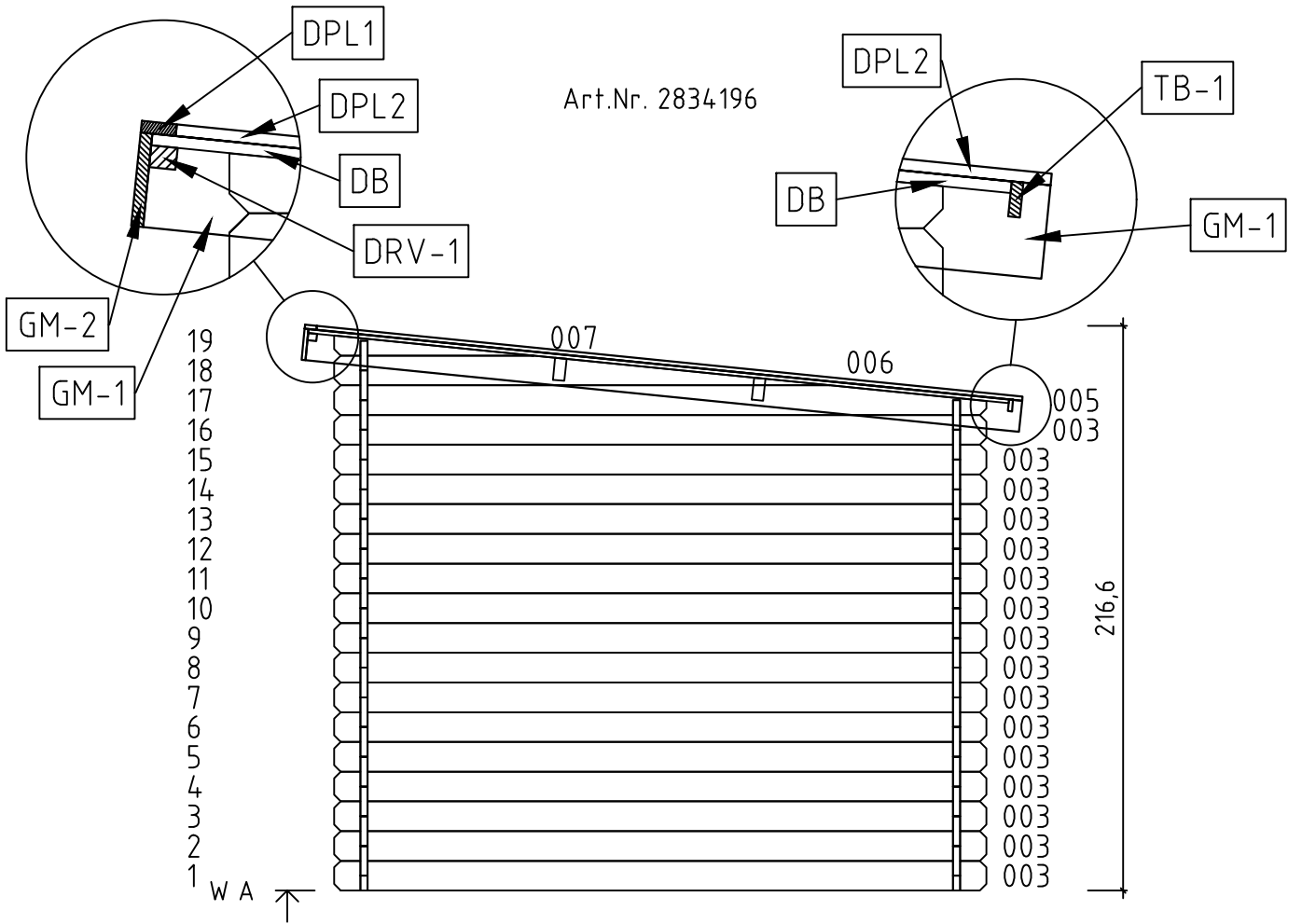

Groundplan - Grundplan - Plan de masse -  
Planimetria - Plattegrond - Põhiplaan

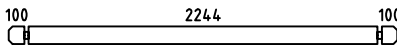
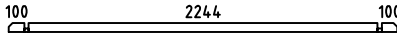
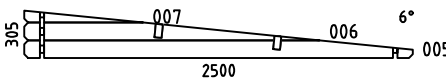
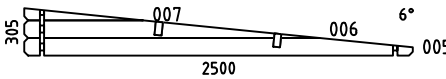
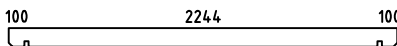
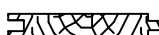



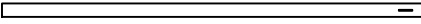

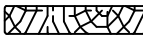

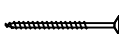
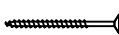
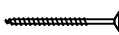
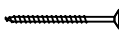
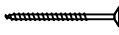

Art.Nr. 2834196

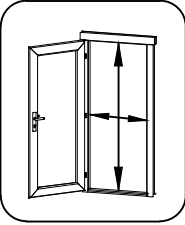
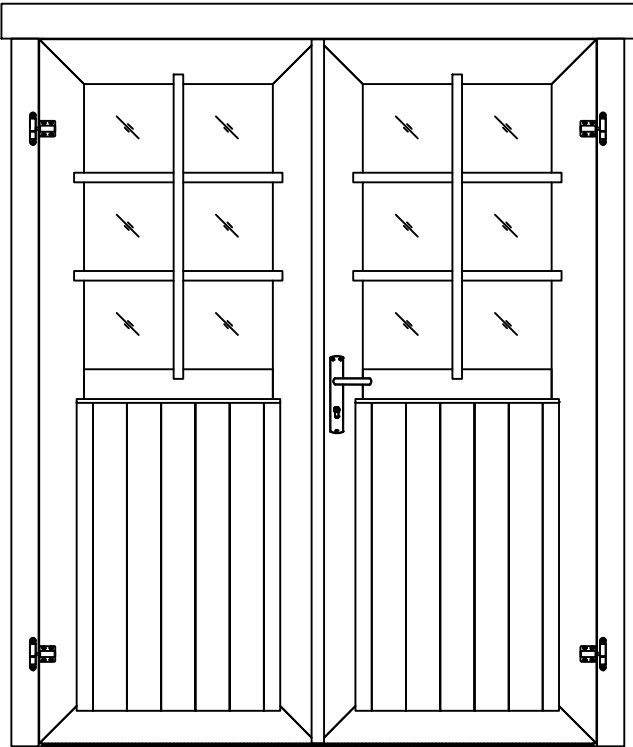

Pos	22.10.2023 Piece list - Stückliste - Liste des pièces - Elementi - Stuklijst - Elementos - Tükítabel Art.Nr. 2834196	5/6	Q	P (mm)	L (mm)
001 1157			2	28x57	500
002 1220			32	28x114	500
003 929			50	28x114	2500
004 928			1	28x57	2500
WA-1 27899			1		
WB-1 27899			1		
A-PR1 33306	Roof beam - Dachbalken - Panne de toit - Perlina del tetto - Gordingen / dakbalk - Correa - Pärilin 		2	44x120	2500
DB 12547	Roof boards - Dachbretter - Voliges - Perlina per tetto - Dakhout - Tablero de tejado - Katuselaud 		28	90x15.5	2700
DPL1 34484	Roofing felt fillet - Dachpappenleiste - Baguette de fixation du feutre bitumeux - Asse per fissaggio guaina bituminosa - Afdekljst asfaltpapier - Moldura de fieltro para tejado - Katusepapiliist 		1	15x45	2530
DPL2 34485	Roofing felt fillet - Dachpappenleiste - Baguette de fixation du feutre bitumeux - Asse per fissaggio guaina bituminosa - Afdekljst asfaltpapier - Moldura de fieltro para tejado - Katusepapiliist 		2	15x45	2720
TB1-1 27998	Fascia board - Traufbrett - Bandeau de toit - Finitura lati tetto - Gevellijst - Tablero de alero - Räästalaud 		1	15x45	2500
DRV-1 1600	Roof edge reinforcement - Dachrandverstärkung - Corniere de renfort de bord de toit - Rinforzo x tetto - Dakrand versterking - Refuerzo de aleros - Räästatugevdus 		1	28x34	2500
KFS-1 2249	Storm protection - Sturmleiste - Latte anti-tempete - Protezione anti vento - Stormverankering / beveiliging - Moldura antitormenta - Tormikinnitustiist 		2	22x45	2050
KFS-2 27180	Storm protection - Sturmleiste - Latte anti-tempete - Protezione anti vento - Stormverankering / beveiliging - Moldura antitormenta - Tormikinnitustiist 		2	22x45	2500
GM2 34486	Gable moulding - Giebelleiste - Planche de rive - Finitura per frontale e retro del tetto - Gevellijst - Tablero de frontón - Viilulaud 		1	15x120	2530
GM1 34487	Gable moulding - Giebelleiste - Planche de rive - Finitura per frontale e retro del tetto - Gevellijst - Tablero de frontón - Viilulaud 		2	15x120	2750
HS9 5106	Screw for gable moulding - Schrauben für giebelleiste - Vis pour fixation planche de rive - Vite per fissare finiture davanti e dietro del tetto - Schroef voor gevellijst - Tornillo para tablero de frontón - Kruvi viilulauale 		16	3.5x50	
HS4 5102	Screw for fascia boards - Schrauben für traufbretter - Vis pour fixation bandeau de toit - Viti x striscia del tetto - Schroef voor gevellijst - Tornillo para tablero de alero - Kruvi räästalauale 		6	3x30	
HS12 5109	Screw for roof edge reinforcement - Schrauben für dachrandverstärkung - Vis pour fixation corniere renfort de bord de toit - Viti x rinforzo bordo tetto - Schroef voor dakrand versterking - Tornillo para refuerzo de alero - Kruvi räästatugevduseite 		6	4x40	
HS12 5109	Screw for gable moulding - Schrauben für giebelleiste - Vis pour fixation planche de rive - Vite per fissare finiture davanti e dietro del tetto - Schroef voor gevellijst - Tornillo para tablero de frontón - Kruvi viilulauale 		6	4x40	
HS18 5113	Screw for roof beams - Schrauben für dachbalken - Vis pour fixation pannes de toit - Viti per perlina del tetto - Schroef voor gordingen / dakbalken - Tornillo para correas - Kruvi pärlinitele 		4	5x120	

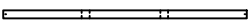
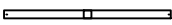

Pos	19.12.2017	Piece list - Stückliste - Liste des pièces - Elementi - Stuklijst - Tükítabel 14 94x1850 TUK.2.056.SVP.MMX28 SGA+28	1/2	Q	P (mm)	L (mm)
Glass size - Glasgröße - Taille de la vitre - Misura del vetro - Glas afmeting - Klaasi mõõt: 502x750 mm					 1418x1794 mm	
						
1	Upper door jamb - Türrahmen oben - Cadre de porte supérieur - Telaio superiore della porta - Bovendorpel - Ukse ülemine leng			1	66x100	1628
2	Left door jamb - Türrahmen links - Cadre de porte gauche - Telaio montante sinistro della porta - Linkerstijl deurframe - Ukse vasak leng			1	66x80	1850
3	Right door jamb - Türrahmen rechts - Cadre de porte droit - Telaio montante destro della porta - Rechterstijl deurframe - Ukse parem leng			1	66x80	1850
4	Doorstep - Swelle - Barre de seuil - Soglia della porta - Deurdorpel - Lävepakk			1	20x21	1418
5	Connection strip - Deckleiste - Baguette de battement - Profilo verticale della porta - Stulplijst - Kokkuvalltsiliist			1	13x32	1812
6	Georgian bars - Sprossen - Croisillons - La griglia georgiana - Raamverdeling - Petteliistud			2	15x25	784
7	Georgian bars - Sprossen - Croisillons - La griglia georgiana - Raamverdeling - Petteliistud			4	15x25	536







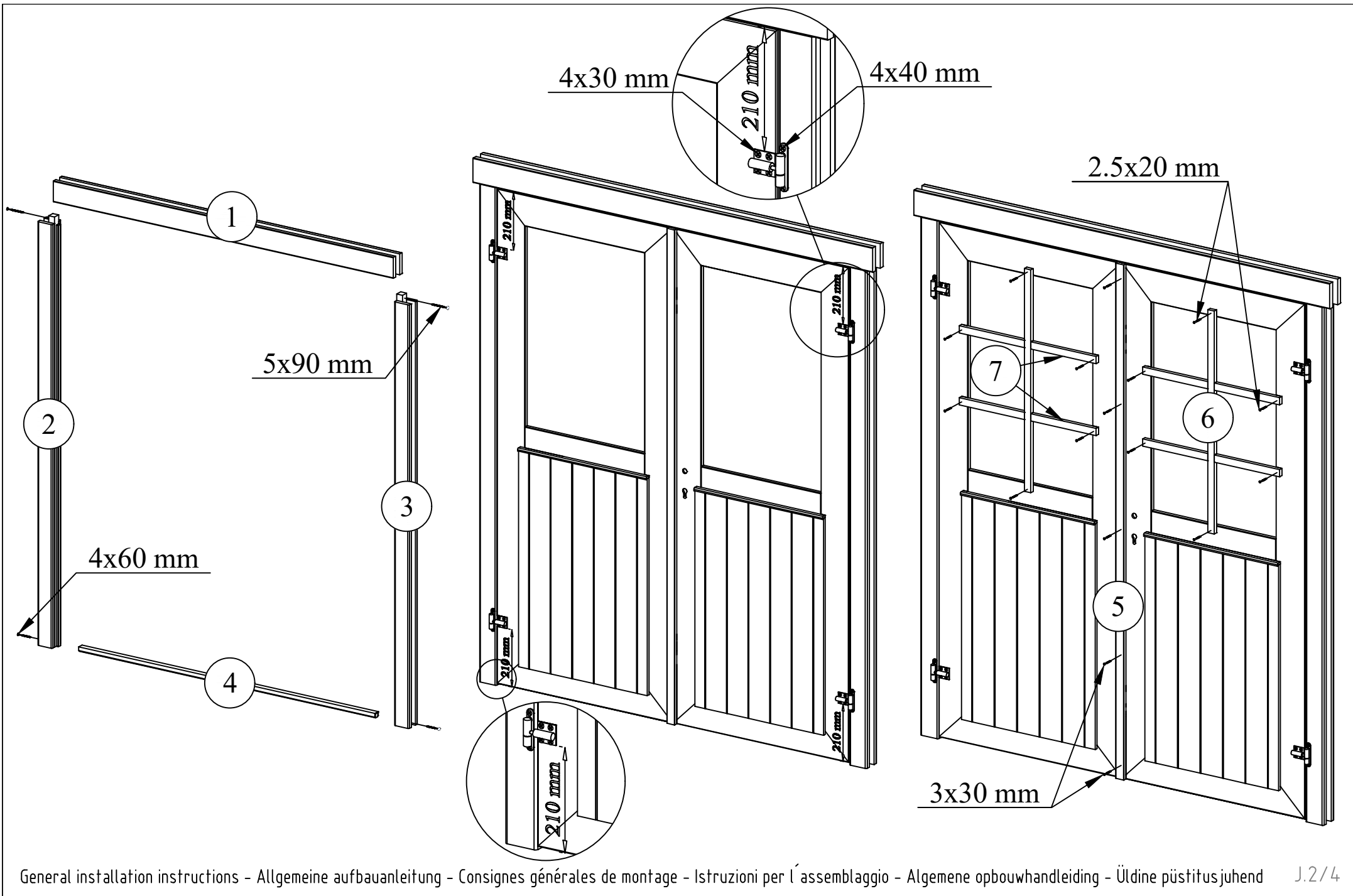

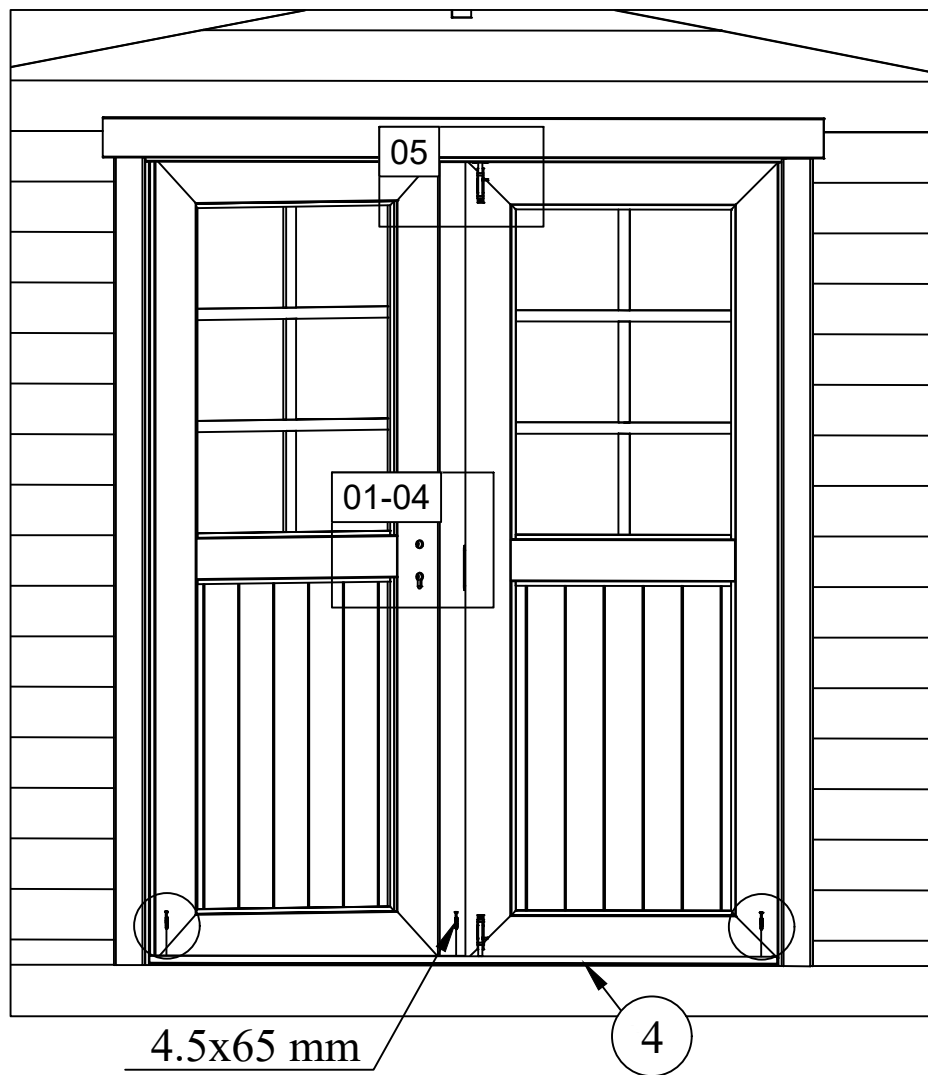

01



04



02



05



03



06

